

1 Form A High-Voltage Solid State Relay

Features

- Current Limit Protection
- Isolation Test Voltage 5300 V_{RMS}
- Typical R_{ON} 28 Ω
- Load Voltage 350 V
- Load Current 120 mA
- High Surge Capability
- Clean Bounce Free Switching
- Low Power Consumption
- High Reliability Monolithic Detector
- SMD Lead Available on Tape and Reel
- Lead-free component
- Component in accordance to RoHS 2002/95/EC and WEEE 2002/96/EC

Agency Approvals

- UL1577, File No. E52744 System Code H or J, Double Protection
- BAPT/BSI Certified

Applications

General Telecom Switching

- On/off Hook Control
- Ring Delay
- Dial Pulse
- Ground Start
- Ground Fault Protection

Instrumentation

Industrial Controls

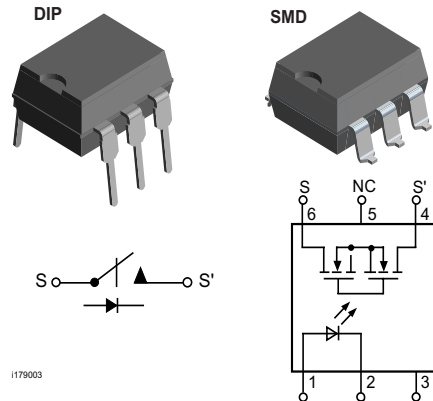

Description

The LH1550 is robust, ideal for telecom and ground fault applications. It is a SPST normally open switch (1 Form A) that replaces electromechanical relays in many applications. It is similar to the LH1540, but has a characteristically higher On resistance. It is constructed using a GaAlAs LED for actuation control and an integrated monolithic die for the switch output. The die, fabricated in a high-voltage dielectrically isolated technology, is comprised of a photodiode array, switch control circuitry and MOSFET switches. In addition, it employs current-limiting circuitry which meets FCC 68.302 and other regulatory voltage surge requirements when overvoltage protection is provided.

Order Information

Part	Remarks
LH1550AT1	Thru Hole, DIP-6
LH1550AAB1	SMD-6
LH1550AAB1TR	Tape and Reel, SMD-6

Absolute Maximum Ratings, $T_{amb} = 25\text{ }^{\circ}\text{C}$

Stresses in excess of the absolute Maximum Ratings can cause permanent damage to the device. Functional operation of the device is not implied at these or any other conditions in excess of those given in the operational sections of this document. Exposure to absolute Maximum Ratings for extended periods of time can adversely affect reliability.

SSR

Parameter	Test condition	Symbol	Value	Unit
LED continuous forward current		I_F	50	mA
LED reverse voltage	$I_R \leq 10\text{ }\mu\text{A}$	V_R	8.0	V
DC or peak AC load voltage	$I_L \leq 50\text{ }\mu\text{A}$	V_L	350	V
Continuous DC load current - bidirectional operation		I_L	100	mA
Peak load current (single shot)	$t = 100\text{ ms}$	I_P	1)	
Ambient temperature range		T_{amb}	- 40 to + 85	$^{\circ}\text{C}$
Storage temperature range		T_{stg}	- 40 to + 150	$^{\circ}\text{C}$
Pin soldering temperature	$t = 10\text{ s max}$	T_{sld}	260	$^{\circ}\text{C}$
Input/output isolation voltage	$V_{RMS}\ t = 1.0\text{ s}, I_{ISO} = 10\text{ }\mu\text{A}$	V_{ISO}	5300	V_{RMS}
Output power dissipation (continuous)		P_{diss}	550	mW

1) Refer to Current Limit Performance Application Note 58 for a discussion on relay operation during transient currents.

Electrical Characteristics, $T_{amb} = 25\text{ }^{\circ}\text{C}$

Minimum and maximum values are testing requirements. Typical values are characteristics of the device and are the result of engineering evaluations. Typical values are for information only and are not part of the testing requirements.

Input

Parameter	Test condition	Symbol	Min	Typ.	Max	Unit
LED forward current, switch turn-on	$I_L = 100\text{ mA}, t = 10\text{ ms}$	I_{Fon}		1.1	2.0	mA
LED forward current, switch turn-off	$V_L = \pm 350\text{ V}$	I_{Foff}	0.001	1.0	-	mA
LED forward voltage	$I_F = 10\text{ mA}$	V_F	1.15	1.25	1.45	V

Output

Parameter	Test condition	Symbol	Min	Typ.	Max	Unit
ON-resistance, ac: Pin 4 (\pm) to 6 (\pm)	$I_F = 5.0\text{ mA}, I_L = 50\text{ mA}$	R_{ON}		28	50	Ω
OFF-resistance	$I_F = 0\text{ mA}, V_L = \pm 100\text{ V}$	R_{OFF}	0.5	300	-	$\text{G}\Omega$
Current limit ac/dc	$I_F = 5.0\text{ mA}, t = 5.0\text{ ms}, V_L = 6.0\text{ V}$	I_{LMT}	170	210	250	mA
Off-state leakage current	$I_F = 0\text{ mA}, V_L = \pm 100\text{ V}$	I_O		0.35	200	nA
	$I_F = 0\text{ mA}, V_L = \pm 350\text{ V}$	I_O		0.09	1.0	μA
Output capacitance Pin 4 to 6	$I_F = 0\text{ mA}, V_L = 1.0\text{ V}$	C_O		18		pF
	$I_F = 0\text{ mA}, V_L = 50\text{ V}$	C_O		7		pF
Switch Offset	$I_F = 5.0\text{ mA}$	V_{OS}		0.3		μV

Transfer

Parameter	Test condition	Symbol	Min	Typ.	Max	Unit
Capacitance (input-output)	$V_{ISO} = 1.0\text{ V}$	C_{IO}		0.7		pF
Turn-on time	$I_F = 5.0\text{ mA}$, $I_L = 50\text{ mA}$	t_{on}		1.1	3.0	ms
Turn-off time	$I_F = 5.0\text{ mA}$, $I_L = 50\text{ mA}$	t_{off}		0.7	3.0	ms

Typical Characteristics ($T_{amb} = 25\text{ }^\circ\text{C}$ unless otherwise specified)

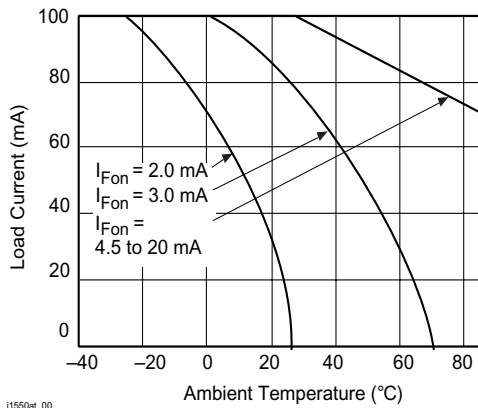

i1550at_00

Figure 1. Recommended Operating Conditions

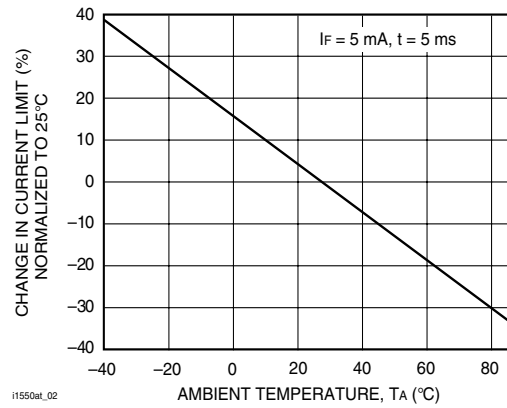

i1550at_02

Figure 3. Current Limit vs. Temperature

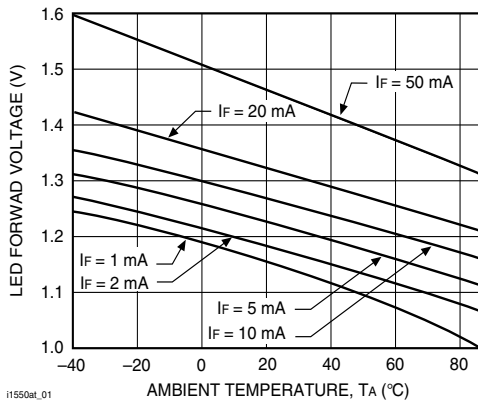

i1550at_01

Figure 2. LED Voltage vs. Temperature

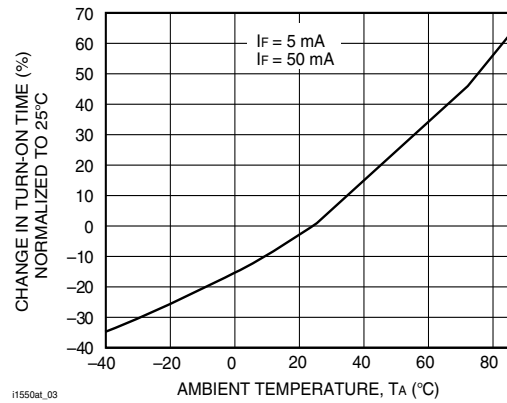

i1550at_03

Figure 4. Turn-on Time vs. Temperature

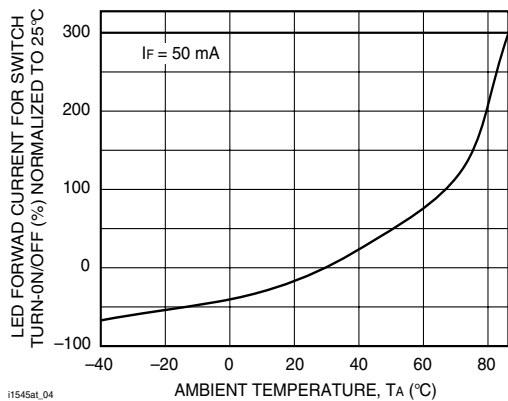

11545at_04

Figure 5. LED Current for Switch Turn-on/off vs. Temperature

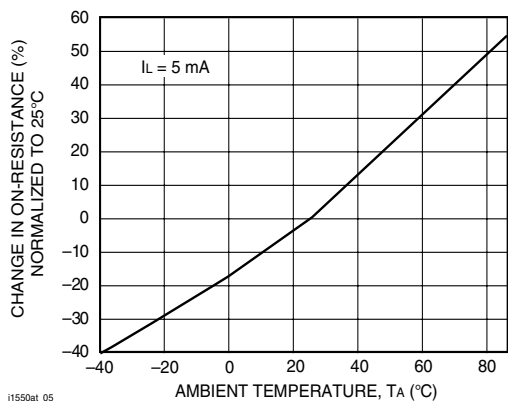

11550at_05

Figure 6. ON-Resistance vs. Temperature

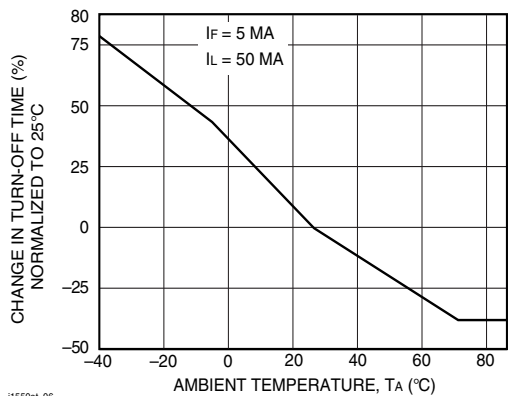

11550at_06

Figure 7. Turn-off Time vs. Temperature

Ozone Depleting Substances Policy Statement

It is the policy of Vishay Semiconductor GmbH to

1. Meet all present and future national and international statutory requirements.
2. Regularly and continuously improve the performance of our products, processes, distribution and operating systems with respect to their impact on the health and safety of our employees and the public, as well as their impact on the environment.

It is particular concern to control or eliminate releases of those substances into the atmosphere which are known as ozone depleting substances (ODSs).

The Montreal Protocol (1987) and its London Amendments (1990) intend to severely restrict the use of ODSs and forbid their use within the next ten years. Various national and international initiatives are pressing for an earlier ban on these substances.

Vishay Semiconductor GmbH has been able to use its policy of continuous improvements to eliminate the use of ODSs listed in the following documents.

1. Annex A, B and list of transitional substances of the Montreal Protocol and the London Amendments respectively
2. Class I and II ozone depleting substances in the Clean Air Act Amendments of 1990 by the Environmental Protection Agency (EPA) in the USA
3. Council Decision 88/540/EEC and 91/690/EEC Annex A, B and C (transitional substances) respectively.

Vishay Semiconductor GmbH can certify that our semiconductors are not manufactured with ozone depleting substances and do not contain such substances.

We reserve the right to make changes to improve technical design
and may do so without further notice.

Parameters can vary in different applications. All operating parameters must be validated for each customer application by the customer. Should the buyer use Vishay Semiconductors products for any unintended or unauthorized application, the buyer shall indemnify Vishay Semiconductors against all claims, costs, damages, and expenses, arising out of, directly or indirectly, any claim of personal damage, injury or death associated with such unintended or unauthorized use.

Vishay Semiconductor GmbH, P.O.B. 3535, D-74025 Heilbronn, Germany
Telephone: 49 (0)7131 67 2831, Fax number: 49 (0)7131 67 2423